

ROBERTS

Sound for Generations



RD-1

FM/DAB digital radio
with *PAUSEplus*

Gemini 1

DAB
Digital Audio Broadcasting

Please read this manual before use

Contents

<i>Controls</i>	2-4	<i>Audio outputs</i>	31
<i>Battery operation</i>	5	<i>Audio 2 setup - DAB</i>	31
<i>Using the AC adaptor</i>	4	<i>Operating your radio autosearch - FM</i>	32
<i>Operating your radio - DAB</i>	6-7	<i>Operating your radio manual tune - FM</i>	33
<i>Secondary services - DAB</i>	8	<i>Presetting stations - DAB & FM</i>	34
<i>Display modes - DAB</i>	8	<i>Recalling preset stations - DAB & FM</i>	34
<i>Using your radios Pause Plus feature - DAB</i>	9	<i>Clock settings</i>	35-37
<i>Pause Plus - rewind - DAB</i>	10	<i>Alarms</i>	38
<i>Pause Plus - record (internal memory) - DAB</i>	11	<i>Buzzer alarm</i>	38-39
<i>Pause Plus - play (internal memory) - DAB</i>	11	<i>Radio alarm</i>	40-42
<i>Pause Plus - record (SD card) - DAB</i>	12	<i>Snooze function</i>	43
<i>Pause Plus - play (SD card) - DAB</i>	12	<i>Sleep timer</i>	43-44
<i>Pause Plus - storage settings - DAB</i>	13-16	<i>Display settings</i>	45
<i>Record Timer - DAB</i>	17-19	<i>Display settings - Display saving</i>	45
<i>SD Card format - DAB</i>	20-21	<i>Display settings - Display backlight</i>	46
<i>Programme type - DAB</i>	22	<i>Display settings - Contrast</i>	47
<i>Favourites - DAB</i>	23	<i>Keypress settings - Timeout</i>	48
<i>Manual tuning - DAB</i>	24	<i>Keypress settings - KeyBeep</i>	49
<i>Service status - DAB</i>	25-26	<i>Factory default</i>	50
<i>Dynamic Range Control (DRC) settings - DAB</i>	27	<i>Headphone socket</i>	51
<i>Tuning range - DAB</i>	28	<i>General</i>	52
<i>Digital output - DAB</i>	29	<i>Circuit features</i>	52
<i>Radio Data Interface (RDI) output - DAB</i>	30	<i>Guarantee</i>	54

Controls

(Front)

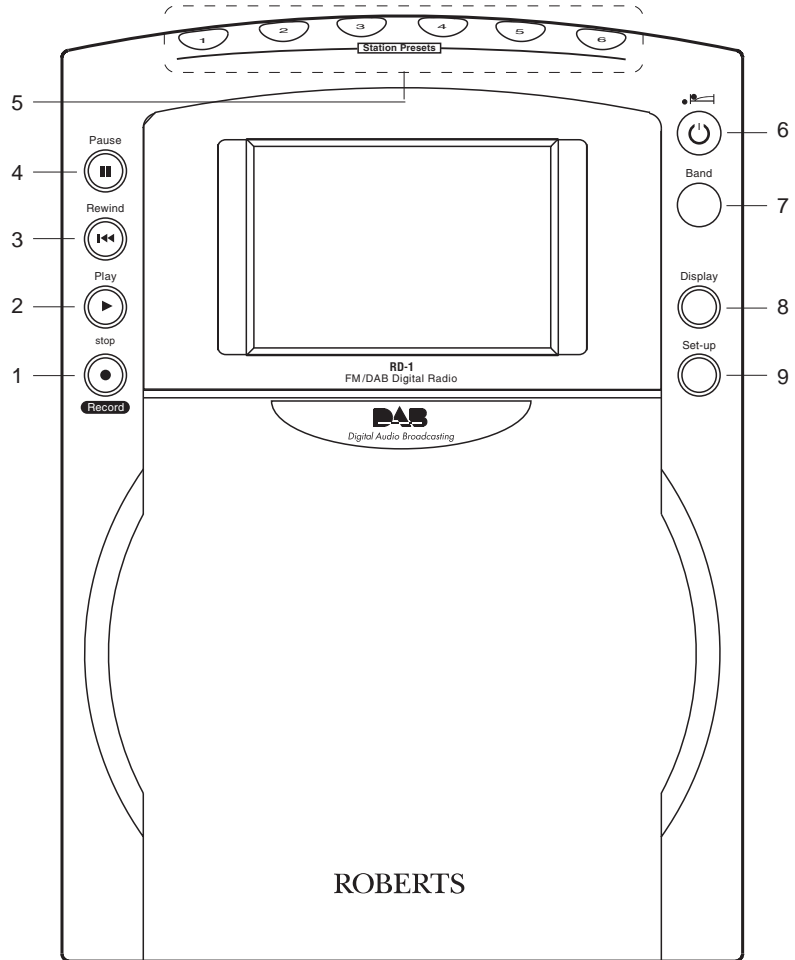

1. Record button
2. Play button
3. Rewind button
4. **PAUSEplus** button
5. Preset buttons
6. On/Off and sleep button
7. Band button
8. Display button
9. Set-up button

If you need any further advice, please call our Technical Helpline on :-
020 8758 0338 (Mon-Fri)

Controls (Left side)

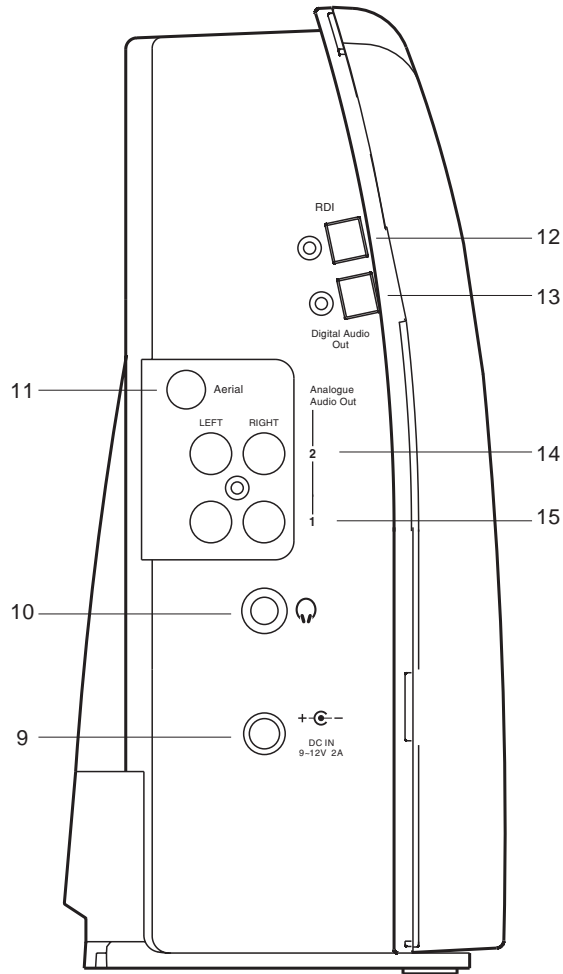

- 9. DC input socket
- 10. Headphone socket
- 11. Telescopic aerial
- 12. RDI output socket
- 13. Digital audio output socket
- 14. Analogue audio 2 output socket
- 15. Analogue audio 1 output socket

Controls (Right side)

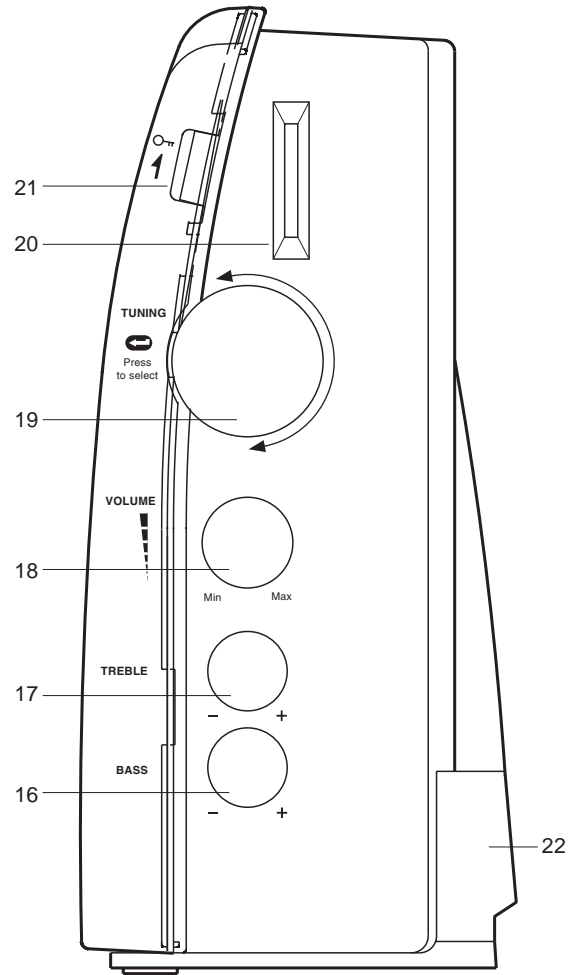

- 16. Bass control
- 17. Treble control
- 18. Volume control
- 19. Tuning control
- 20. SD card socket
- 21. Lock Switch
- 22. Battery compartment

If you need any further advice, please call our Technical Helpline on :-
020 8758 0338 (Mon-Fri)

Battery operation

1. Remove the **Battery cover** on the rear of the unit by pushing the catches as shown.
2. Insert four LR20 (D size) batteries into the spaces in the compartment. Take care to ensure all batteries are inserted with the correct polarity as shown inside the battery compartment. Replace the battery cover.
3. Reduced power, distortion and a 'stuttering' sound are all signs that the batteries may need replacing.
4. If the radio is not to be used for any extended period of time it is recommended that the batteries are removed from the radio.

Battery life

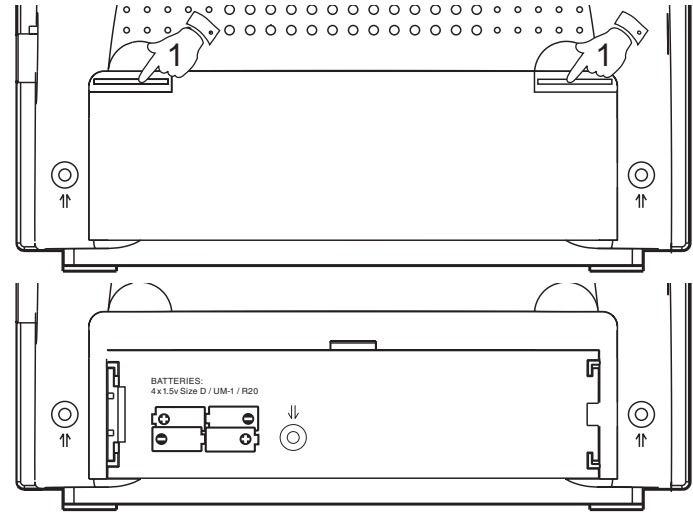

Using the AC adaptor

1. Place your radio on a flat surface.
2. Insert the adaptor plug into the DC socket located on the left side of your radio.
3. Plug the adaptor into a standard 13 amp mains socket outlet. Whenever the adaptor is used the batteries are automatically disconnected.

The AC adaptor should be disconnected from the mains supply and the radio when not in use.

We would recommend for economy that your radio is used via the AC adaptor whenever possible with battery operation for occasional or stand-by use only.

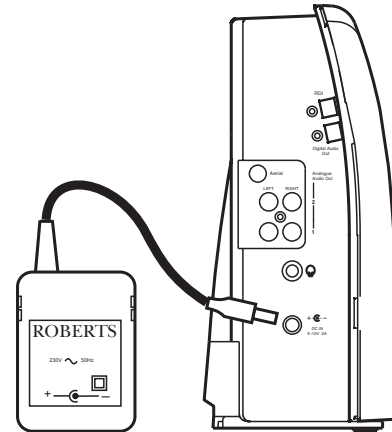

Operating your radio - DAB

1. Fully extend the telescopic aerial.
2. Press the **On/Off button** to switch on your radio. If this is the first time the radio is used the display will show *DAB Auto Tune* and a quick scan of UK Band III DAB channels will be carried out.
If the radio has been used before the last used station will be selected.
4. During Auto Tune as each group of stations is detected the bottom line of the display will show the number of stations found. The display will also show a bargraph indicating progress of the Autotune.
5. When the Auto Tune is complete the first station (in numeric-alpha order 0...9...A....Z) will be selected.
6. If the station list is still empty after the DAB Auto Tune your radio will display *No DAB Service*.
7. If no signals are found it may be necessary to relocate your radio to a position giving better reception.

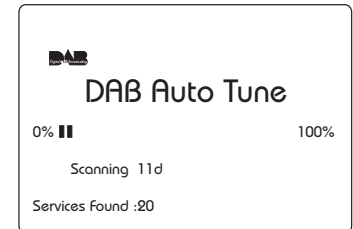
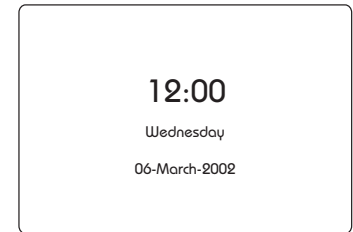
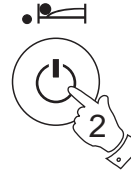

Operating your radio - DAB

1. Fully extend the telescopic aerial.
2. Press the **On/Off button** to switch on your radio.
3. Rotate the **Tuning control** until the station list appears.
4. Continue to rotate the **Tuning control** until the required station appears between the two black bars on the display.
5. Press in and **release the Tuning control** to select the station. The required station will be selected and after a few seconds the Dynamic Label System text (DLS) will appear on the display.
6. Adjust the **Volume, Bass and Treble controls** to the required settings.

Note: To return to normal station mode from station list without selecting a station press and release the Display button.

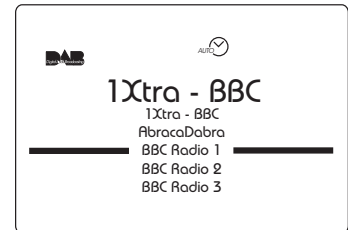
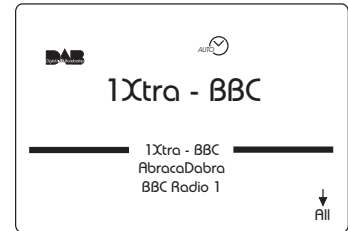
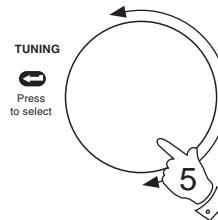
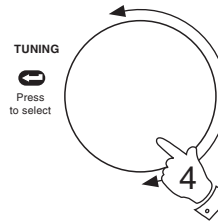
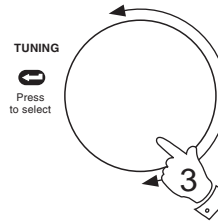

Secondary services - DAB

1. Certain radio stations have one or more secondary services associated with them. If a station has a secondary service the top line of the display will show Secondary. To select the secondary service Press in and **release the Tuning control**.
2. To change back to the primary service Press in and release the **Tuning control**.

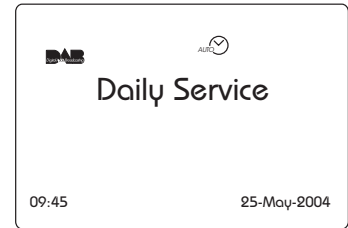
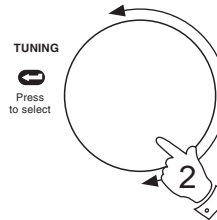
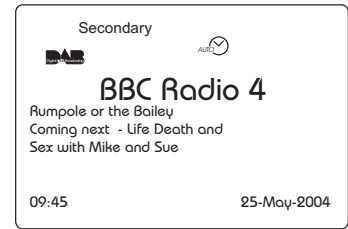
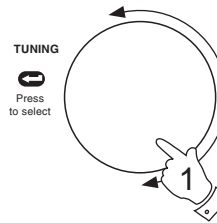

Display modes - DAB

Your radio has two display modes - normal mode shows Station name and information text (DLS) - extended mode shows extra information such as Programme type, Multiplex name, Signal strength and Battery level.

1. Press the **Display button** to change display mode
2. Press the **Display button** to change back to original display mode.

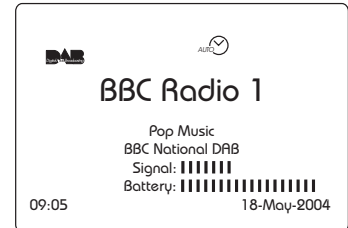
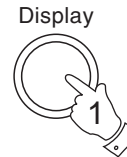

If you need any further advice, please call our Technical Helpline on :-
020 8758 0338 (Mon-Fri)

Using your radio's Pause Plus feature - DAB

How many times has your favourite radio station been interrupted by that phone call from a double glazing firm or someone selling that must have item? Sound familiar? Now with a single press of the **PAUSEplus** button you can put your favourite station on hold while you answer that important call. After the call or other important task is finished simply press the **PAUSEplus** button to return to your favourite station exactly where you left off so that you never miss a single word.

Radio stations can effectively be put on hold for typically 15 minutes but can be up to 30 minutes depending on the DAB storage settings (see page 13)

Note the **PAUSEplus feature only operates on the DAB waveband.**

1. To place your radio in **PAUSEplus** mode simply press the **PAUSEplus** button, the sound from the loudspeaker will be muted. The display will show the time station was paused, duration of pause and remaining pause time available.
2. To return to the radio station that you were listening to simply press the **PAUSEplus** button and your radio will continue playing from where you left off. The display will show the amount by which you are behind real time together with the remaining pause time.
3. To return to real time press and release the **Rewind button**, the display will return to previous mode prior to **PAUSEplus** operation.



Rewind



Pause Plus Rewind - DAB

1. As soon as you switch on your radio the **PAUSEplus** feature is working silently in the background so, say for example, you want to hear a news item again press the **Rewind button** and rotate the tuning control clockwise to scroll back to the item you wish to listen. The display will show the amount of time you have scrolled back together with the maximum time you can rewind back to.

Note the **PAUSEplus rewind memory only starts when your radio is switched on.**

2. To return to real time press the **Rewind button**.
3. Rewind memory is typically 15 minutes but can be up to 30 minutes depending on the DAB storage settings (see page 13)

Note the **PAUSEplus rewind feature only operates on the DAB waveband.**

Rewind



TUNING
Press
to select

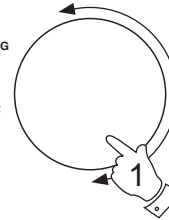

Rewind

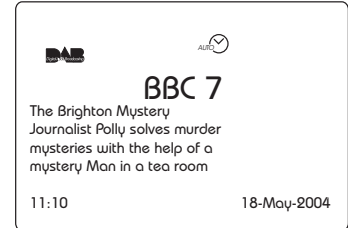

Pause Plus Record (internal memory) - DAB

1. Your radio can record to its internal memory for typically 30 minutes but can be up to 1 hour depending on DAB storage settings (see page 13) and the programme you are listening to.
2. Press and hold in the **Record button** until the display shows Recording.
3. The display will show the recording duration together with the remaining record time available.
4. Press the **Record button** to stop the recording.

Note: If the SD card becomes full during the recording the display will show **Memory Full**. Press the Record button to stop the recording and press again to return to normal mode.

Pause Plus - play (internal memory)

1. Press the **Play button** to commence playback of a previous recording.
2. When the playback has finished the display will show *Warning End of File*.
3. Press the **Play button** twice, after a few seconds your radio will return to normal radio mode.

Note the PAUSEplus record/play internal memory is cleared when changing band or switching off your radio

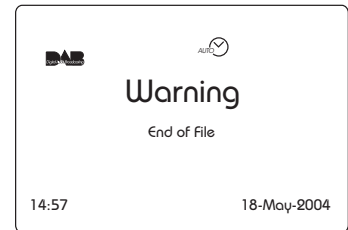
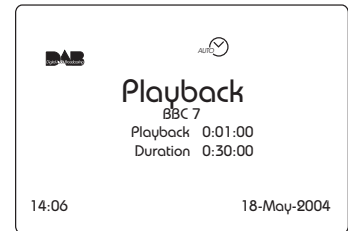
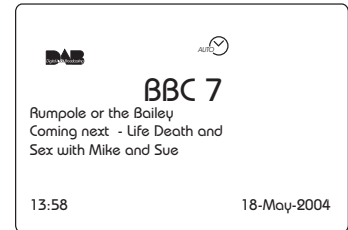

Pause Plus - record (SD card)

Your radio is supplied with a 32MB SD card which will give typically 30 minutes record time but can be over 1 hour depending on program type.

1. Insert the SD card into the slot located on the top right side of your radio. The display will show SDCard Inserted.
2. Press and hold in the **Record button** until the display shows Recording.
3. The display will show the recording duration together with the remaining record time available.
4. Press the **Record button** to stop the recording.



Note: Record function is provided for personal use only

Pause Plus - play (SD card)

1. Ensure that an SD card is inserted into the slot located on the top right side of your radio. The display will show *SDCard Inserted*.
2. Press the **Play button** to commence playback of previous recording.
3. When the playback has finished the display will show *Warning End of File*.
4. Press the **Play button** twice, after a few seconds your radio will return to normal radio mode.

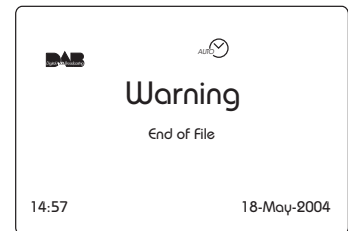
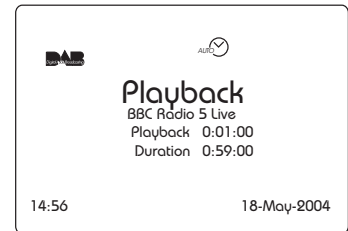
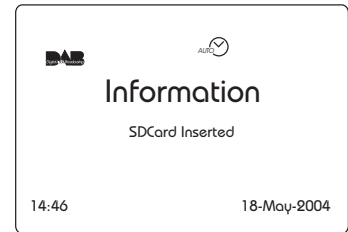

If you need any further advice, please call our Technical Helpline on :-
020 8758 0338 (Mon-Fri)

Pause Plus storage settings - DAB

Your radio's Pause Plus internal storage can be allocated to either Pause/Rewind or to Record. By default the settings are 50% Pause/Rewind and 50% Record.

The default settings are allocated so as to allow typically 15 minutes Pause/Rewind and 15 minutes Record but can be up to 30 minutes for each depending on storage settings, station type and programme content.

Changing the settings to 95% Record (the maximum) will give a record time of typically 30 minutes but can be up to 1 hour depending on station and programme content.

1. Press the **Setup button** to enter the *Setup* menu.
2. Rotate the **Tuning control** until the *DAB* section appears between the two black lines on the display.
3. Press in and release the **Tuning control** to select the *DAB* section.
4. Rotate the **Tuning control** anti-clockwise until *More...* is highlighted on the display.
5. Press in and release the **Tuning control** to select the *More..* section.

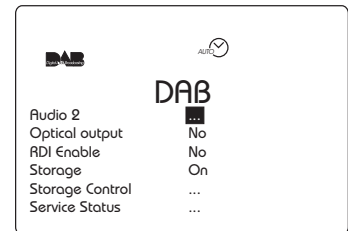
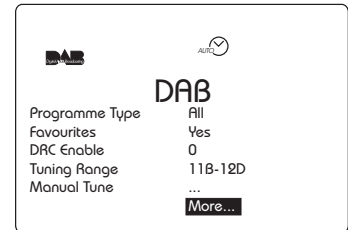
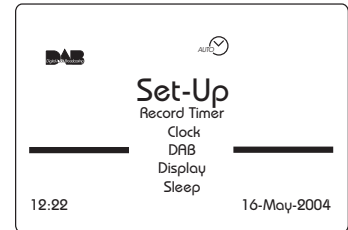
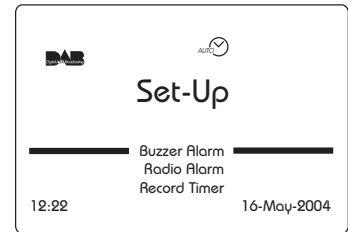
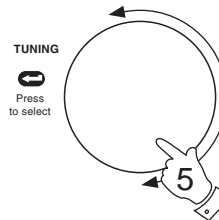
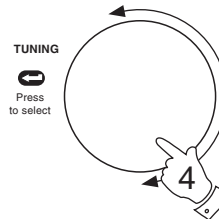
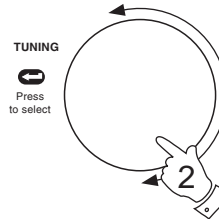

Pause Plus storage settings - DAB (cont.)

6. Rotate the **Tuning control** until the highlight appears on the **Storage Control** line.
7. Press in and release the **Tuning control** to select the **Storage Control** section.
8. Rotate the **Tuning control** until the highlight appears on either the **Rewind** or **Record** storage settings line.
9. Press in and release the **Tuning control** to select the required storage setting and rotate the **Tuning control** to adjust the setting.
10. Press in and release the **Tuning control** to store the change.
11. Repeatedly press and release the **Setup button** until the display returns to show normal station mode.

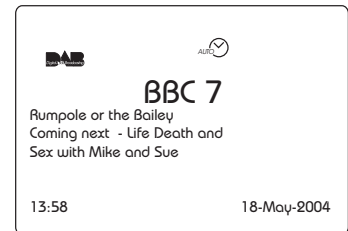
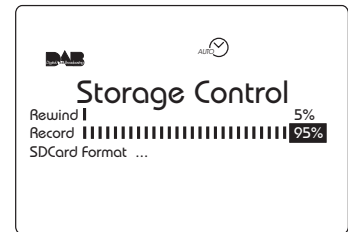
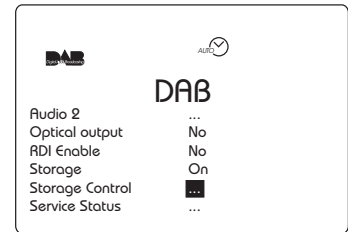
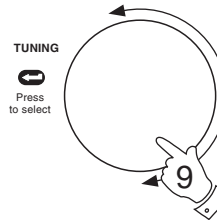
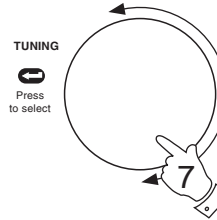
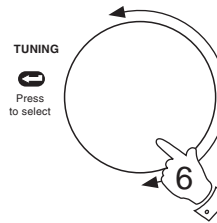

Pause Plus Storage settings - DAB (cont.)

Your radio has three settings for Pause Plus storage. The settings are Off, On and On with AC. With the Pause Plus storage Off the battery life will be extended (typically 25 hours).

1. Press the **Setup button** to enter the *Setup* menu.
2. Rotate the **Tuning control** until the *DAB* section appears between the two black lines on the display.
3. Press in and release the **Tuning control** to select the *DAB* section.
4. Rotate the **Tuning control** until *More...* is highlighted on the display.
5. Press in and release the **Tuning control** to select the *More..* section.

Set-up



TUNING

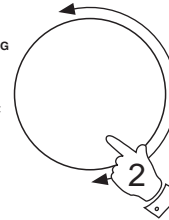

TUNING

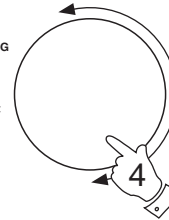

TUNING

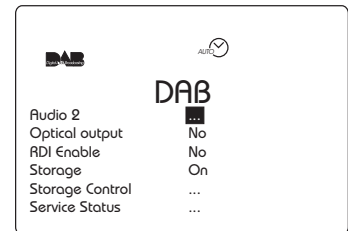
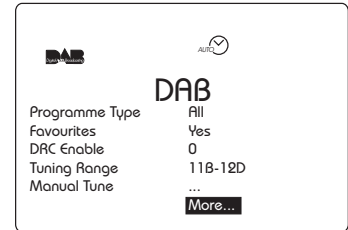
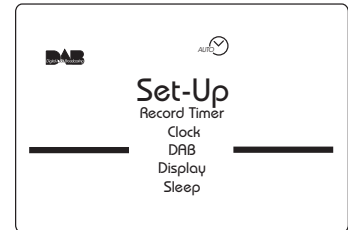
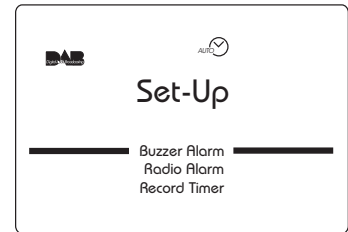
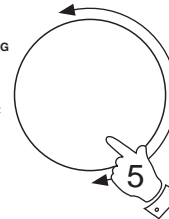

Pause Plus Storage settings - DAB (cont.)

6. Rotate the **Tuning control** until the highlight appears on the **Storage** line.
7. Press in and release the **Tuning control** to select the **Storage** section.
8. Rotate the **Tuning control** to change the **Storage** to the required setting e.g.. **On**, **Off** or **On with AC**.
9. Press in and release the **Tuning control** to store the change.
10. Repeatedly press and release the **Setup button** until the display returns to show normal station mode

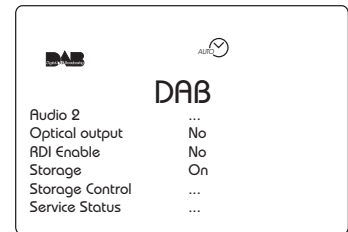
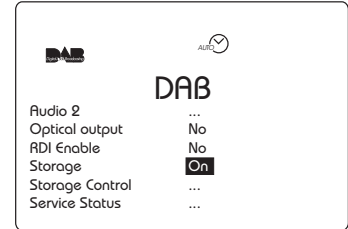
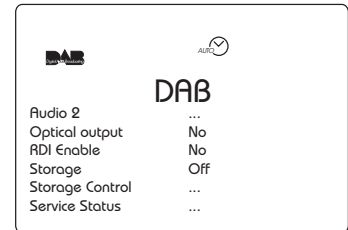
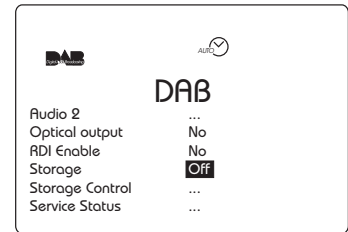
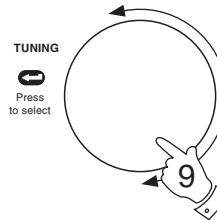
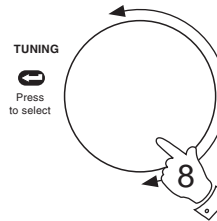
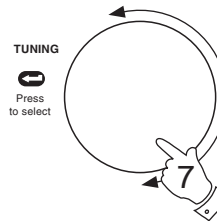
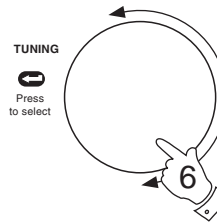

If you need any further advice, please call our Technical Helpline on :-
020 8758 0338 (Mon-Fri)

Record Timer - DAB

Note: *Timer record is only available on DAB via SD card and is provided for personal use only.*

1. Press the **Setup button** to enter *Setup* mode.
2. Rotate the **Tuning control** until the *Record Timer* section appears between the two black lines on the display.
3. Press in and release the **Tuning control** to select the *Record Timer* section.
4. Press in and release the **Tuning control** to enter adjustment mode. Rotate the **Tuning control** to set record timer to On. Press in and release the **Tuning control** to confirm the selection.
5. Rotate the **Tuning control** until *Days* line is highlighted in the display (default is all days active)
6. Press in and release the **Tuning Control** to confirm selection. Rotate the **Tuning control** to select the required *Day* (see note on page 19)
7. Press in and release the **Tuning control** to confirm the selections.
8. Rotate the **Tuning control** until the *Start* line is highlighted in the display.
9. Press in and release the **Tuning Control** to select. Rotate the **Tuning control** to select required hour.

continued on next page

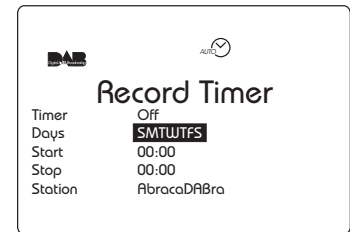
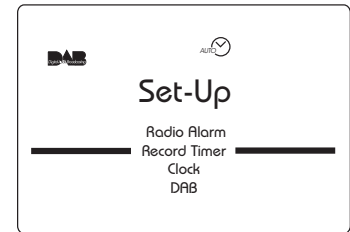
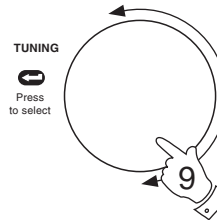
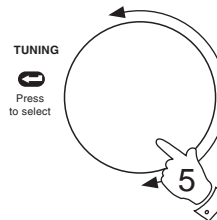
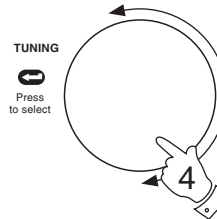
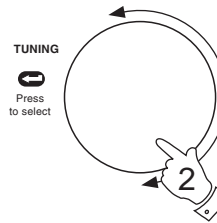

Record Timer - DAB cont.

10. Press in and release the **Tuning control** to confirm selection.
Rotate the **Tuning control** to select the required minute.

11. Press in and release the **Tuning control** to confirm the selection.

12. Rotate the **Tuning control** until the **Stop** line is highlighted in the display.

13. Press in and release the **Tuning control** to select. Rotate the **Tuning control** to select required hour.

14. Press in and release the **Tuning control** to confirm selection.
Rotate the **Tuning control** to select the required minute.

15. Press in and release the **Tuning control** to confirm the selection.

16. Rotate the **Tuning control** until the **Station** line is highlighted in the display.

17. Press in and release the **Tuning control** to confirm the selection.

18. Rotate the **Tuning control** to select the required station.

19. Press in and release the **Tuning control** to confirm the selection.

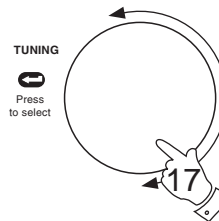
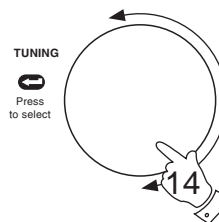
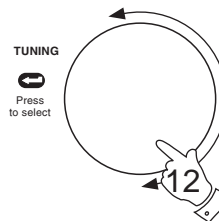
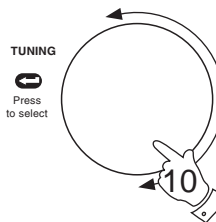

continued on next page

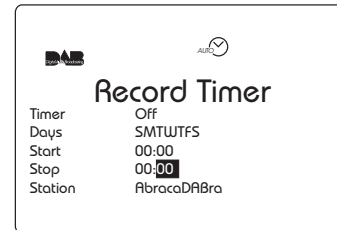
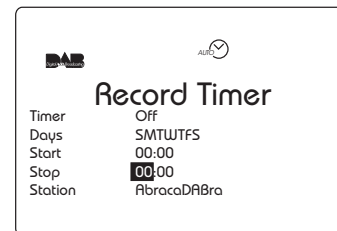
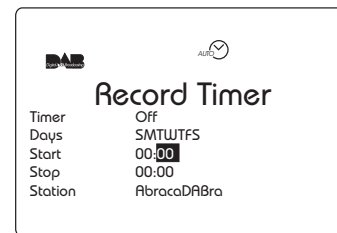

Record Timer - DAB cont.

20. Repeatedly press and release the **Setup button** until the display returns to show normal station mode.
21. Insert SD card with sufficient capacity for required recording (approx. 32MB per 30 mins at 128 kbits/sec - 1hour at 64 kbits/sec) the display will show SD card Inserted.
22. Press the **On/Off button** to switch off your radio. If no SD card is inserted the warning message *Warning Record Timer Set Insert SDCard!* will appear.
23. Your radio will switch on at the selected time and record the chosen program. The loudspeaker will be muted during the Timed recording. The loudspeaker may be un-muted by pressing the Pause Plus button.

Note: If record timer is set to record on more than one day of the week it will be necessary to change the SD card after each days recording otherwise the recording will be overwritten. The filing system on your RD-1 only allows one recording per SD card regardless of recording length.

Set-up

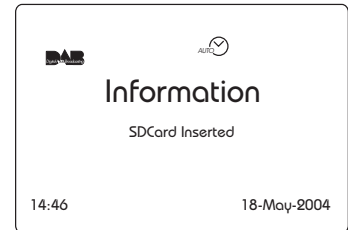
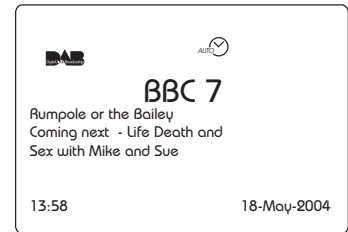

SD Card Format - DAB

This formats your SD card erasing any previously recorded files. It also allows an SD card formatted on another device to be re-formatted for use on your radio.

1. Insert an SD card into the slot. Press the **Setup button** to enter the **Setup** menu.
2. Rotate the **Tuning control** until the DAB section appears between the two black lines on the display.
3. Press in and release the **Tuning control** to select the DAB section.
4. Rotate the **Tuning control** until **More...** is highlighted on the display.
5. Press in and release the **Tuning control** to select the **More...** section.

Set-up

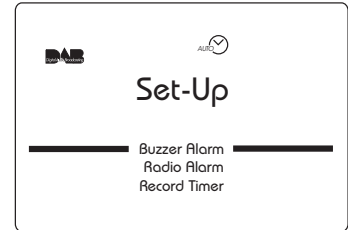

TUNING
Press to select

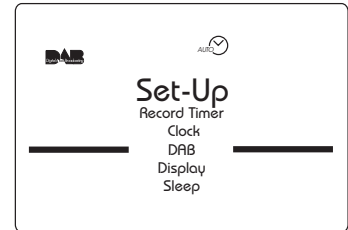
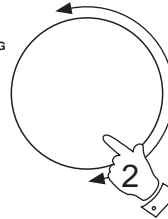

TUNING
Press to select

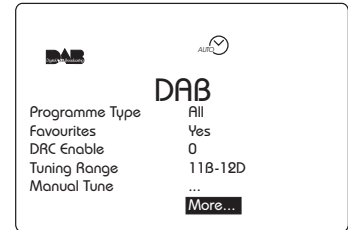
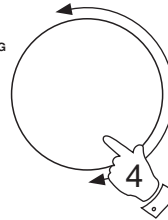

TUNING
Press to select

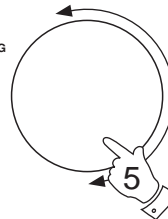

continued on next page
If you need any further advice, please call our Technical Helpline on :-
020 8758 0338 (Mon-Fri)

SD Card Format - DAB cont.

6. Rotate the **Tuning control** until the highlight appears on the **Storage Control** line.
7. Press in and release the **Tuning control** to select the **Storage Control** section.
8. Rotate the **Tuning control** until the highlight appears on the **SDCard Format** line.
9. Press in and release the **Tuning control** to enter adjust mode.
10. Rotate the **Tuning control** to select Yes.
11. Press in and release the **Tuning control** to confirm the selection. After a few seconds the display will show **Information SDCard Formatted**.
12. Repeatedly press and release the **Setup button** until the display returns to show normal station mode.

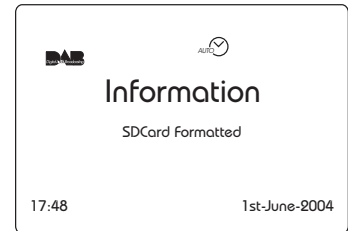
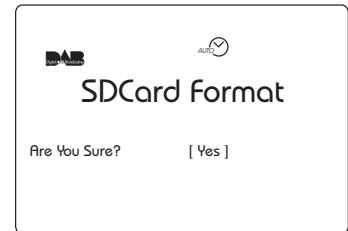
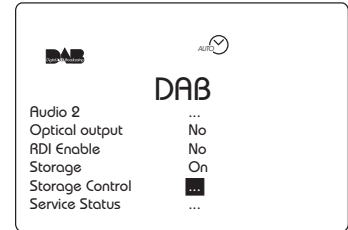
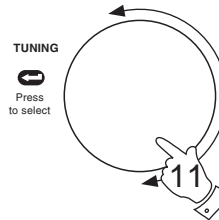
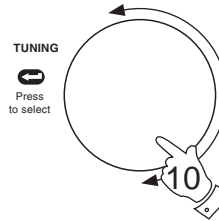
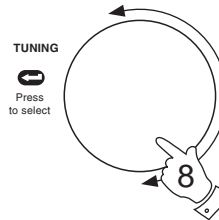
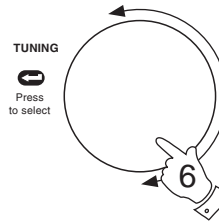

Programme Type - DAB

Your radio can be set so that only one particular type of programme appears in the station list e.g. *Rock, Pop, Classic*, etc. The default setting is *All*.

1. Press the **Setup button** to enter *Setup* menu.
2. Rotate the **Tuning control** until the *DAB* section appears between the two black lines on the display. Press in and release the **Tuning control** to confirm the selection
3. Rotate the **Tuning control** until the *Programme Type* line is highlighted in the display.
4. Press in and release the **Tuning control** to enter adjustment mode.
5. Rotate the **Tuning control** to select just one programme type setting e.g. *All, Rock, Pop, Classic*, etc..
6. Press in and release the **Tuning control** to confirm the selection.
7. Repeatedly press and release the **Setup button** until the display returns to show normal station mode.
8. When you next enter tuning list mode only the station type as selected will be shown.

Set-up

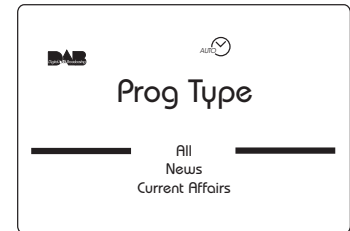
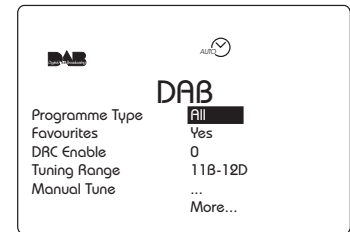
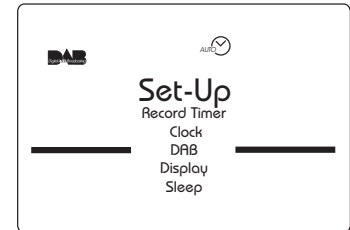
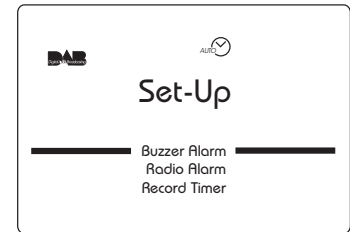
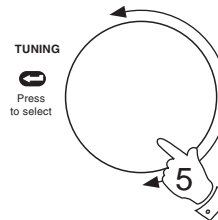
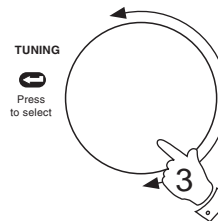
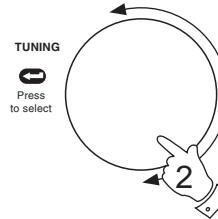

If you need any further advice, please call our Technical Helpline on :-
020 8758 0338 (Mon-Fri)

Favourites - DAB

When this setting is switched on the most listened to stations will move to the top of the station list and be marked with the ♥ symbol.

1. Press the **Setup button** to enter *Setup* menu.
2. Rotate the **Tuning control** until the *DAB* section appears between the two black lines on the display. Press in and release the **Tuning control** to confirm the selection
3. Rotate the **Tuning control** until the *Favourites* line is highlighted in the display.
4. Press in and release the **Tuning control** to enter adjustment mode.
5. Rotate the **Tuning control** to select required favourites setting e.g. *Yes or No*.
6. Press in and release the **Tuning control** to confirm the selection.
7. Repeatedly press and release the **Setup button** until the display returns to show normal station mode.
8. After a period of time the most listened to stations will move up to the top of the station list and be marked with the ♥ symbol..

Set-up

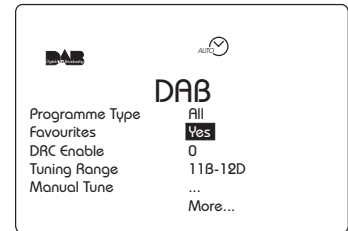
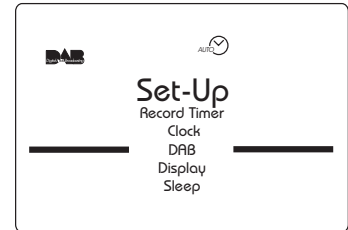
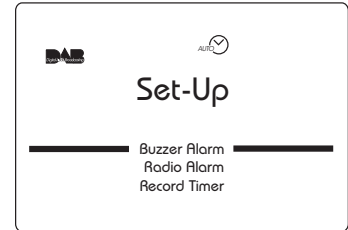
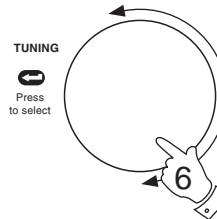
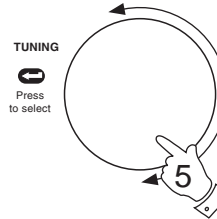
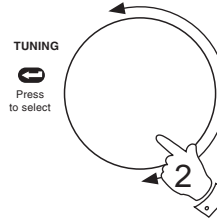

Manual Tuning - DAB

Manual tuning allows you to tune directly to the various DAB Band III channels. UK DAB stations are located in the range 11B to 12D.

1. Press the **Setup button** to enter *Setup* menu.
2. Rotate the **Tuning control** until the *DAB* section appears between the two black lines on the display. Press in and release the **Tuning control** to confirm the selection
3. Rotate the **Tuning control** until the *Manual Tune* line is highlighted in the display. Press in and release the **Tuning control** to confirm the selection
4. Rotate the **Tuning control** until the *T-DAB* line is highlighted in the display.
5. Press in and release the **Tuning control** to enter adjustment mode.
6. Rotate the **Tuning control** to select required DAB channel. Press in and release the **Tuning control** to confirm the selection.
7. Press either the **Band** or **Display buttons** to select the stations contained within the Multiplex for the selected DAB channel.
8. Repeatedly press and release the **Setup button** until the display returns to show normal station mode.
9. The current station will remain selected.

Set-up

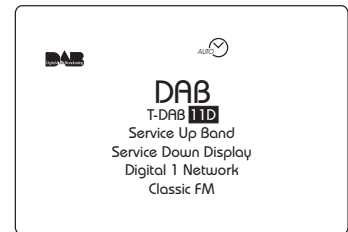
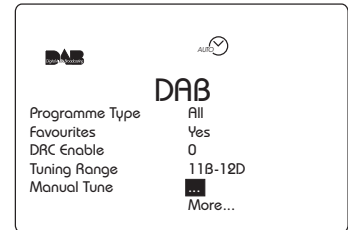
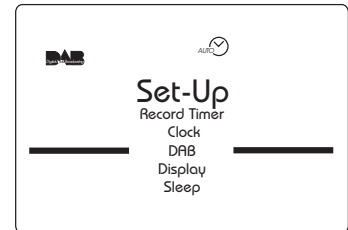
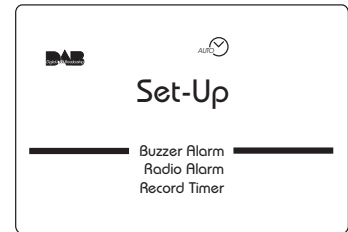
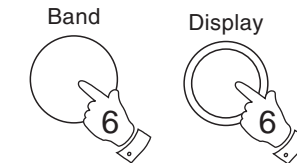
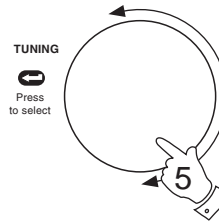
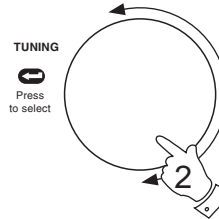

If you need any further advice, please call our Technical Helpline on :-
020 8758 0338 (Mon-Fri)

Service Status - DAB

This display gives extended information about the currently selected station.

1. Press the **Setup button** to enter the *Setup* menu.
2. Rotate the **Tuning control** until the DAB section appears between the two black lines on the display.
3. Press in and release the **Tuning control** to select the DAB section.
4. Rotate the **Tuning control** until *More...* is highlighted on the display.
5. Press in and release the **Tuning control** to select the *More..* section.

Set-up

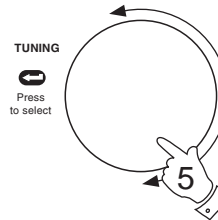
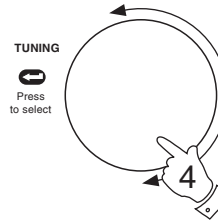
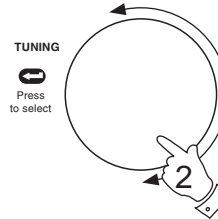

continued on next page

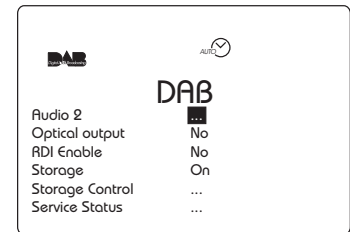
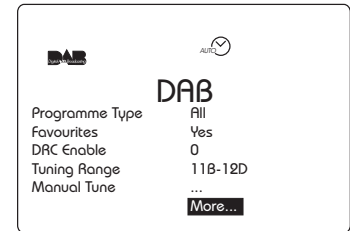
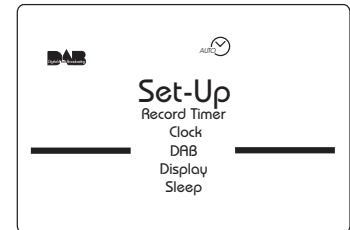
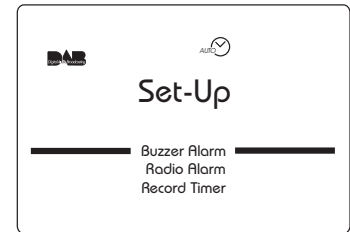

Service Status cont.

6. Rotate the **Tuning control** until the highlight appears on the **Service Status** line.
7. Press in and release the **Tuning control** to select the **Service Status**.
8. The display will show Multiplex name, Mono/Stereo mode, T-DAB channel number, Frequency, DAB mode and Bit Rate.
9. Repeatedly press and release the **Setup button** until the display returns to show normal station mode.

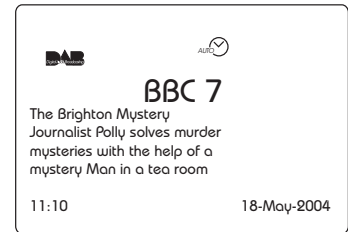
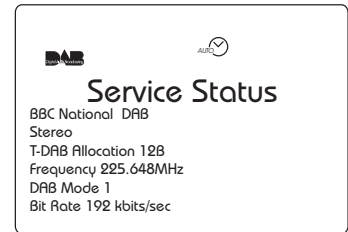
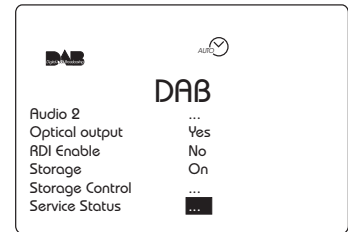
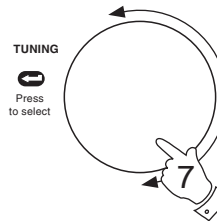
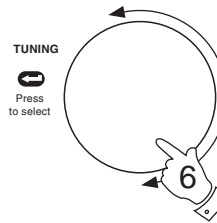

Dynamic Range Control (DRC) settings - DAB

DRC can make quieter sounds easier to hear when your radio is used in a noisy environment. Currently only BBC Radio 3 broadcasts a DRC level.

1. Press the **Setup button** to enter *Setup* menu.
2. Rotate the **Tuning control** until the *DAB* section appears between the two black lines on the display. Press in and release the **Tuning control** to confirm the selection
3. Rotate the **Tuning control** until the *DRC Enable* line is highlighted in the display.
4. Press in and release the **Tuning control** to enter adjustment mode.
5. Rotate the **Tuning control** to select required DRC setting (default is 0) :-

DRC 0 DRC is switched off . Broadcast DRC level will be ignored.

DRC 1/2 DRC level is set to 1/2 that sent by broadcaster.

DRC 1 DRC is set as sent by broadcaster.

6. Press in and release the **Tuning control** to confirm the selection.

7. Repeatedly press and release the **Setup button** until the display returns to show normal station mode.

Set-up

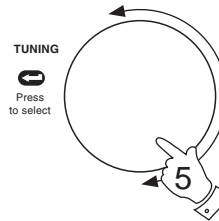
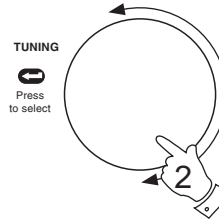

Set-up

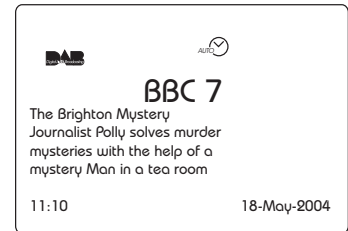
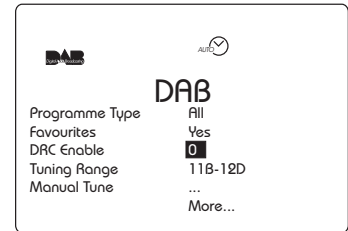
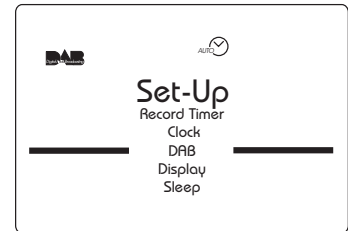
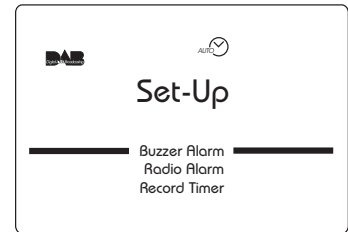

Tuning range - DAB

Note: Changes to these settings should only be made if radio is to be used outside of UK.

Should you take your radio to another country which also has Band III DAB broadcasts it may be necessary to change the default tuning range. Your RD-1 will tune across the full DAB Band III range.

1. Press the **Setup button** to enter *Setup* menu.
2. Rotate the **Tuning control** until the *DAB* section appears between the two black lines on the display. Press in and release the **Tuning control** to confirm the selection
3. Rotate the **Tuning control** until the *Tuning Range* line is highlighted in the display.
4. Press in and release the **Tuning control** to enter adjustment mode.
5. Rotate the **Tuning control** to select required lower channel. Press in and release the **Tuning control** to confirm the selection.
6. Rotate the **Tuning control** to select required upper channel. Press in and release the **Tuning control** to confirm the selection.
7. Repeatedly press and release the **Setup button** until the display returns to show normal station mode.
8. When you next perform an Auto Scan your radio will scan using the new tuning range selected.

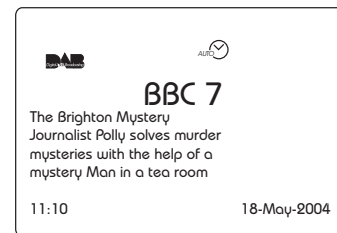
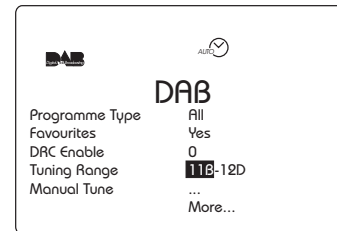
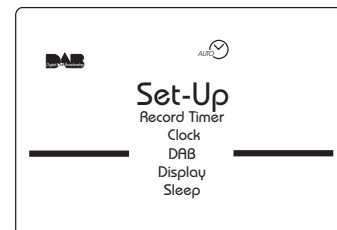
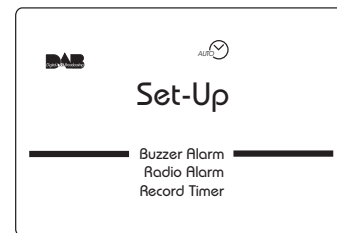
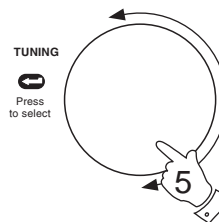
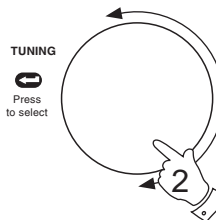

If you need any further advice, please call our Technical Helpline on :-
020 8758 0338 (Mon-Fri)

Digital output - DAB

Your radio is equipped with a digital optical output (TosLink) socket which can be used to connect your radio to a Hi-Fi or mini disc for playback or external recording.

The default setting for the Digital Output is Off (so as to conserve battery life). To switch On the Digital Output proceed as follows:-

1. Press the **Setup button** to enter *Setup* menu.
2. Rotate the **Tuning control** until the *DAB* section appears between the two black lines on the display. Press in and release the **Tuning control** to confirm the selection
3. Rotate the **Tuning control** until the *More...* line is highlighted in the display. Press in and release the **Tuning control** to confirm the selection
4. Rotate the **Tuning control** until the *Digital Output* line is highlighted in the display.
5. Press in and release the **Tuning control** to enter adjustment mode.
6. Rotate the **Tuning control** to select required setting (Yes or No)
Press in and release the **Tuning control** to confirm the selection.
7. Repeatedly press and release the **Setup button** until the display returns to show normal station mode.

Note: when the digital output is switched On Audio 2 will always be the same as Audio 1.

Set-up

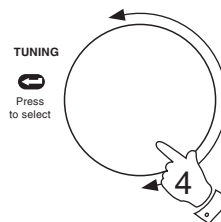
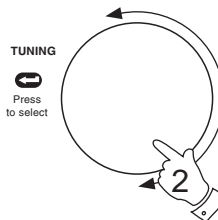

Set-up

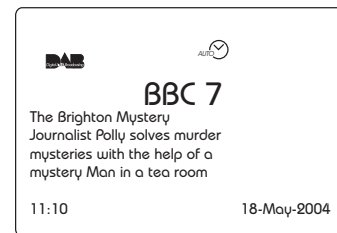
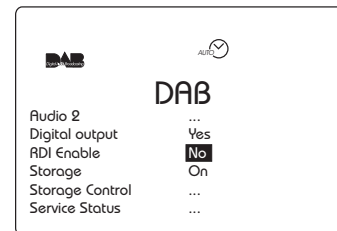
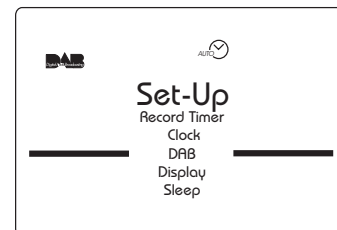
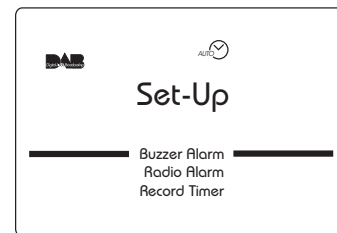

Radio Data Interface (RDI) output - DAB

Your radio is equipped with an RDI optical output socket (TosLink) which can be used to connect your radio to an external data decoder.

The default setting for the RDI optical output is Off (so as to conserve battery life). To switch on the Digital Output proceed as follows:-

1. Press the **Setup button** to enter *Setup* menu.
2. Rotate the **Tuning control** until the *DAB* section appears between the two black lines on the display. Press in and release the **Tuning control** to confirm the selection
3. Rotate the **Tuning control** until the *More...* line is highlighted in the display. Press in and release the **Tuning control** to confirm the selection
4. Rotate the **Tuning control** until the *RDI Enable* line is highlighted in the display.
5. Press in and release the **Tuning control** to enter adjustment mode.
6. Rotate the **Tuning control** to select required setting (Yes or No)
Press in and release the **Tuning control** to confirm the selection.
7. Repeatedly press and release the **Setup button** until the display returns to show normal station mode.

Set-up

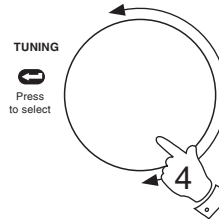
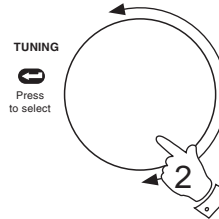

Set-up

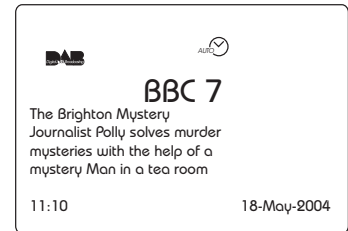
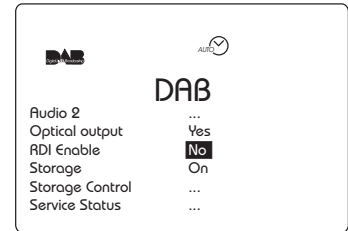
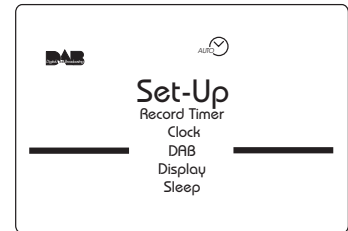
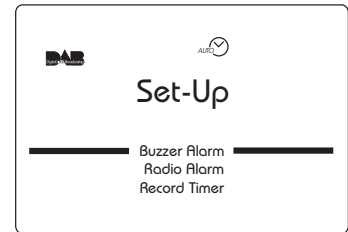

If you need any further advice, please call our Technical Helpline on :-
020 8758 0338 (Mon-Fri)

Audio outputs (analogue)

Your radio has two analogue audio outputs:- Audio 1 outputs to your radio's loudspeaker and to Audio output socket 1. Audio 2 outputs to Audio output socket 2 and can be set to output a different station from Audio 1 providing it is within the same multiplex.

Audio 2 setup - DAB

1. Press the **Setup button** to enter *Setup* menu.
2. Rotate the **Tuning control** until the *DAB* section appears between the two black lines on the display. Press in and release the **Tuning control** to confirm the selection
3. Rotate the **Tuning control** until the *More...* line is highlighted in the display. Press in and release the **Tuning control** to confirm the selection
4. Rotate the **Tuning control** until the *Audio 2* line is highlighted in the display.
5. Press in and release the **Tuning control** to enter station list/select mode.
6. Rotate the **Tuning control** to select required DAB channel. Press in and release the **Tuning control** to confirm the selection.
7. The station selected will be output to Audio output socket 2.
8. Repeatedly press and release the **Setup button** until the display returns to show normal station mode.

Set-up



TUNING



Press to select

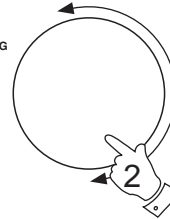

TUNING



Press to select

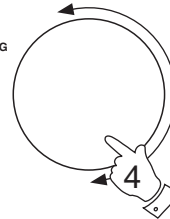

TUNING



Press to select

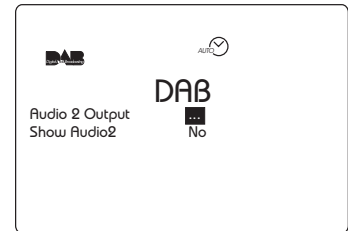
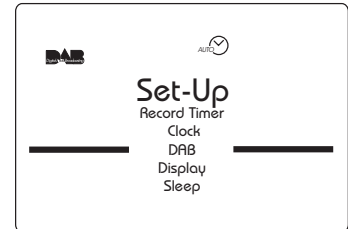
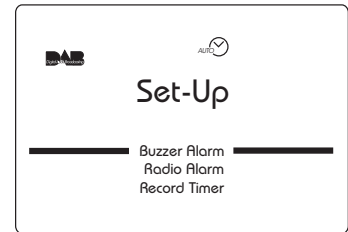
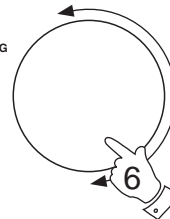

Operating your radio - FM auto search

1. Fully extend the telescopic aerial.
2. Press the **On/Off button** to switch on your radio.
3. Press the **Band button** to select the FM band
4. Press in and release the **Tuning control** the display will show *Auto Search*
5. Rotate the **Tuning control** a few clicks clockwise to search up in frequency or rotate the **Tuning control** a few clicks anti-clockwise to search down in frequency.
6. Your radio will scan the FM waveband, stopping each time it finds a station of sufficient strength.
7. To search for additional stations repeat the above procedure.
8. Adjust the **Volume** , **Bass and Treble controls** to the required settings.

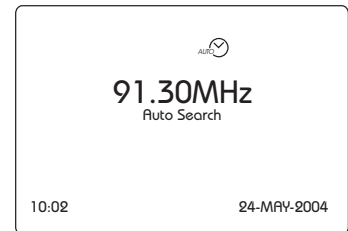
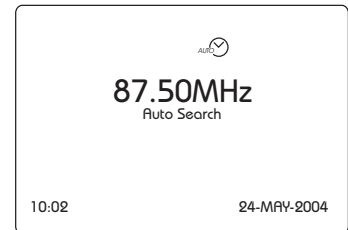
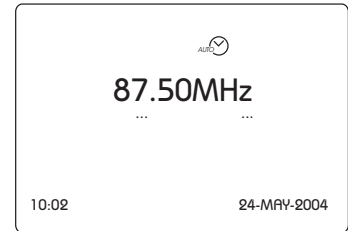
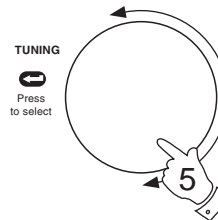
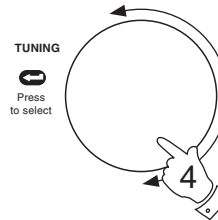

If you need any further advice, please call our Technical Helpline on :-
020 8758 0338 (Mon-Fri)

Operating your radio - FM manual tune

1. Fully extend the telescopic aerial.
2. Press the **On/Off button** to switch on your radio.
3. Press the **Band button** to select the FM band
4. Rotate the **Tuning control** a clockwise to tune up in frequency or rotate the **Tuning control** anti-clockwise to tune down in frequency.
5. Adjust the **Volume, Bass and Treble controls** to the required settings.



Band

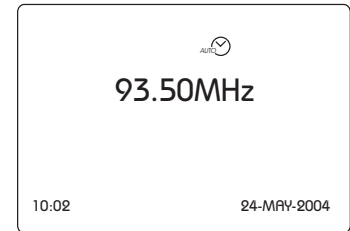
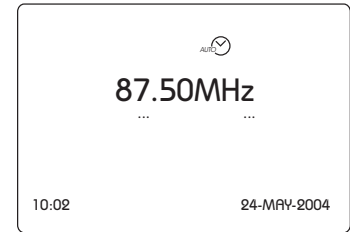
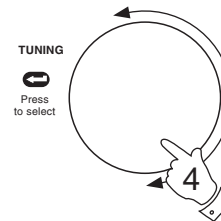
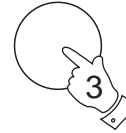

Presetting stations - DAB and FM

There are 6 memory presets for each of the 2 wavebands.

1. Press the **On/Off button** switch on the radio.
2. Tune to the required station as previously described.
3. Press and hold down the required **Preset button** until the display shows *Stored*. The station will be stored under the chosen preset button. Repeat this procedure for the remaining presets.
4. Stations stored in preset memories may be overwritten by following the above procedure.



Recalling a preset station - DAB and FM

1. Press the **On/Off button** to switch on the radio.
2. Select the required waveband by pressing the **Band** button.
3. Momentarily press the required **Preset button**, your radio will tune to the station stored in preset memory.

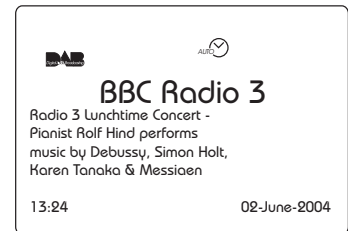

Clock settings

Your radio's clock and date is by default automatically set when first tuned to a DAB station. The clock format (12/24hrs) and date format (dd-mmm-yyyy) may also be changed to suit your preferences.

1. Press the **Setup button** to enter *Setup* menu.
2. Rotate the Tuning **control** until the *Clock* section appears between the two black lines on the display. Press in and release the **Tuning control** to confirm the selection
3. Rotate the **Tuning control** until the *DAB Auto Set* line is highlighted in the display.
4. Press in and release the **Tuning control** to enter adjustment mode. Rotate the **Tuning control** to select the required DAB Auto Set setting (Yes or No)
5. Press in and release the **Tuning control** to confirm the selection.
6. Rotate the **Tuning control** until the *Time Set* line is highlighted in the display.
7. Press in and release the **Tuning Control** to select. Rotate the **Tuning control** to select required hour.

continued on next page

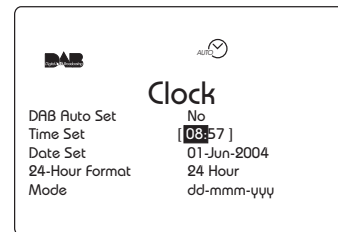
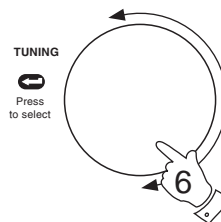
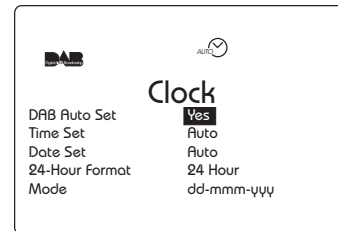
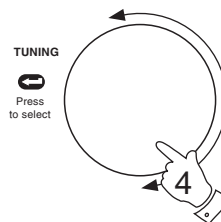
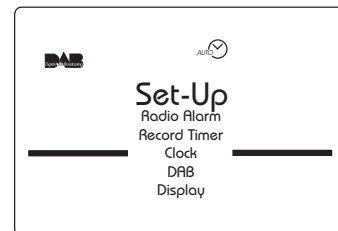
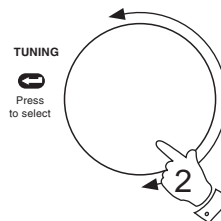
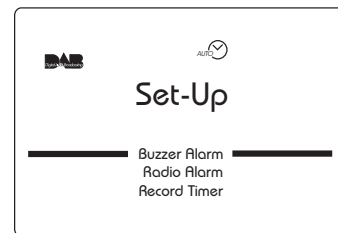

Clock settings cont.

8. Press in and release the **Tuning control** to confirm the selection. Rotate the **Tuning control** to select the required minute.
9. Press in and release the **Tuning control** to confirm the selection.
10. Rotate the **Tuning control** until the *Date Set* line is highlighted in the display.
11. Press in and release the **Tuning Control** to select. Rotate the **Tuning control** to select required Day.
12. Press in and release the **Tuning control** to confirm the selection.
13. Rotate the **Tuning control** to select required Month. Press in and release the **Tuning control** to confirm the selection.
14. Rotate the **Tuning control** to select required Year. Press in and release the **Tuning control** to confirm the selection.

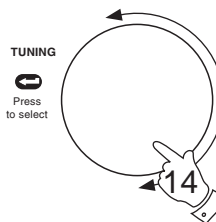
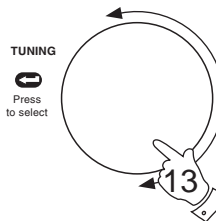
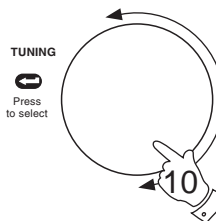
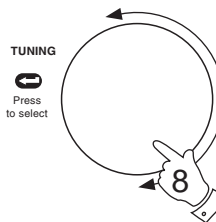

continued on next page

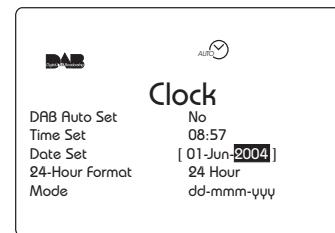
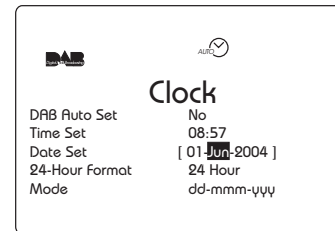
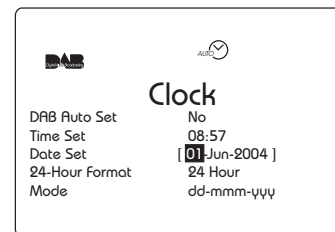
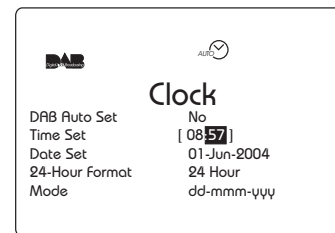

Clock cont.

15. Rotate the **Tuning control** until the *24-Hour Format* line is highlighted in the display. Press in and release the **Tuning control** to enter adjustment mode (default is 24 hours)
16. Rotate the **Tuning control** to select 12 or 24 hour format. Press in and release the **Tuning control** to confirm the selection.
17. Rotate the **Tuning control** until the *Mode* line is highlighted in the display. Press in and release the **Tuning control** to enter adjustment mode.
18. Rotate the **Tuning control** to select required dd-mm-yyyy format. Press in and release the **Tuning control** to confirm the selection (default dd-mm-yyyy)
19. Repeatedly press and release the **Setup button** until the display returns to show normal station mode.

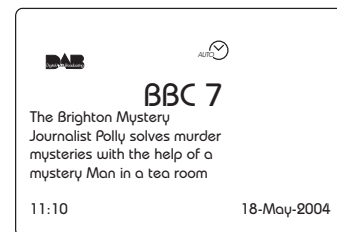
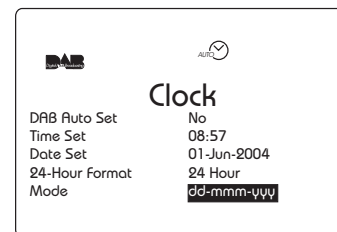
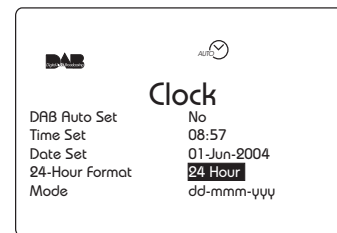
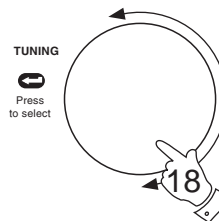
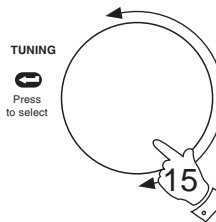

Alarms

Your radio has two alarms - buzzer and radio. Both alarms have a Humane wake system whereby the alarms start at a low level and gradually work up to a high level.

The radio alarm can be set so that you can wake to your favourite station on either of the two wavebands.

Note: Alarm time format (12 or 24 hour) is dependent on the clock settings made on page 37 (default is 24 hour)

Buzzer Alarm

1. Press the **Setup button** to enter setup mode.
2. Press in and release the **Tuning control** to select **Buzzer Alarm**.
3. Rotate the **Tuning control** until **Alarm** line is highlighted in the display.
4. Press in and release the **Tuning Control** to select. Rotate the **Tuning control** to select **Alarm On**.

Set-up



TUNING

Press to select

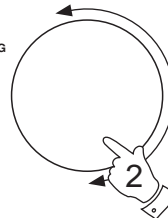

TUNING

Press to select

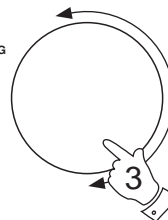

TUNING

Press to select

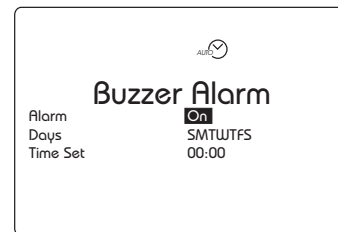
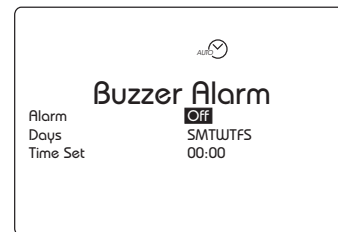
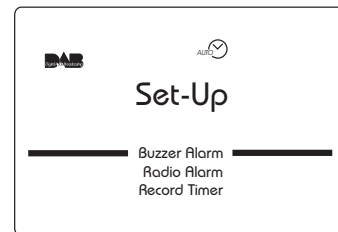
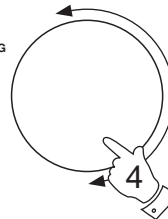

continued on next page

Buzzer Alarm cont.

5. Press in and release the **Tuning control** to confirm selection
6. Rotate the **Tuning control** until *Days* line is highlighted in the display. (default is all days active)
7. Press in and release the **Tuning Control** to select. Rotate the **Tuning control** to select required days.
8. Press in and release the **Tuning control** to confirm the selections.
9. Rotate the **Tuning control** until the *Time Set* line is highlighted in the display.
10. Press in and release the **Tuning Control** to select. Rotate the **Tuning control** to select required hour.
11. Press in and release the **Tuning control** to confirm the selection. Rotate the **Tuning control** to select the required minute.
12. Press in and release the **Tuning control** to confirm the selection.
13. Repeatedly press and release the **Setup button** until the display returns to show normal station mode.
14. The **Buzzer Alarm** active symbol will appear in the display.
15. Press the **On/Off button** to switch off your radio. The alarm will sound on the selected days at the preset time.

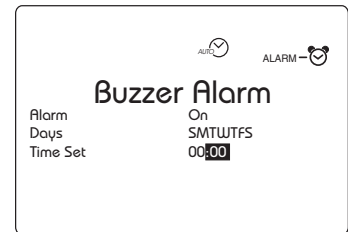
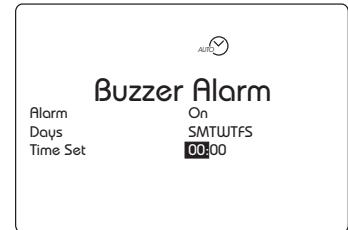
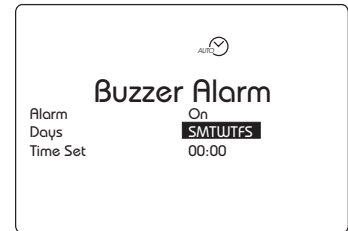
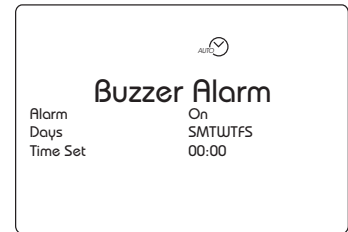
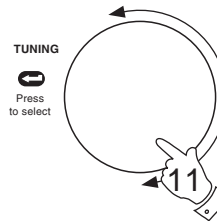
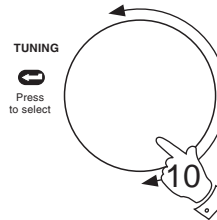
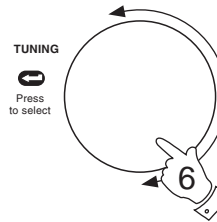
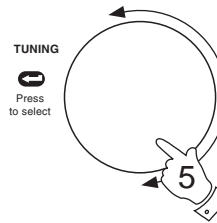

Radio Alarm

Note: Alarm time format (12 or 24 hour) is dependent on the clock settings made on page 37 (default is 24 hour)

1. Press the **Setup button** to enter *Setup* mode.
2. Rotate the **Tuning control** until *Radio Alarm* line appears between the two black bars on the display
3. Press in and release the **Tuning control** to select *Radio Alarm*.
4. Rotate the **Tuning control** until *Alarm* line is highlighted in the display.
5. Press in and release the **Tuning Control** to select. Rotate the **Tuning control** to select *Alarm On*.

Set-up

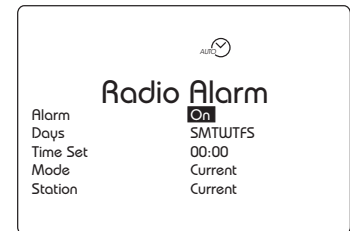
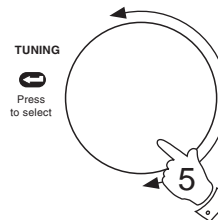
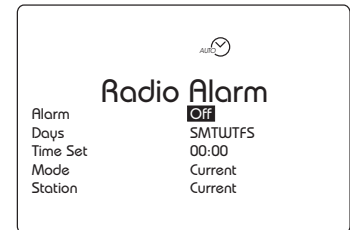
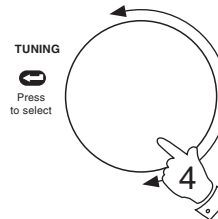
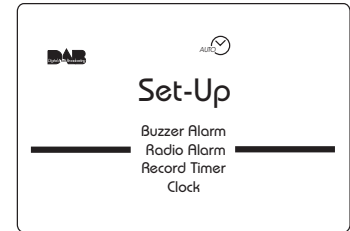
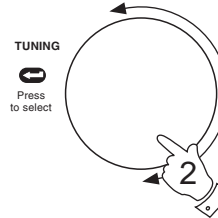

If you need any further advice, please call our Technical Helpline on :-
020 8758 0338 (Mon-Fri)

Radio Alarm cont.

6. Press in and release the **Tuning control** to confirm selection
7. Rotate the **Tuning control** until **Days** line is highlighted in the display. (default is all days active)
8. Press in and release the **Tuning Control** to select. Rotate the **Tuning control** to select required days.
9. Press in and release the **Tuning control** to confirm the selections.
10. Rotate the **Tuning control** until the **Time Set** line is highlighted in the display.
11. Press in and release the **Tuning Control** to select. Rotate the **Tuning control** to select required hour.
12. Press in and release the **Tuning control** to confirm selection. Rotate the **Tuning control** to select the required minute.
13. Press in and release the **Tuning control** to confirm the selection.

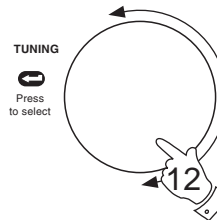
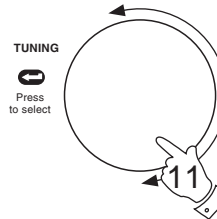
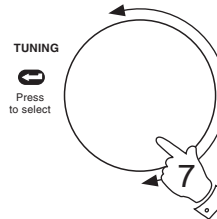
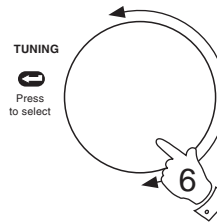

continued on next page

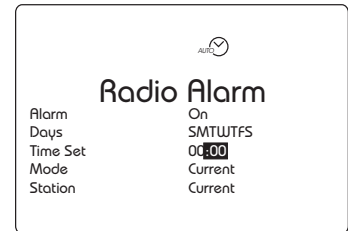
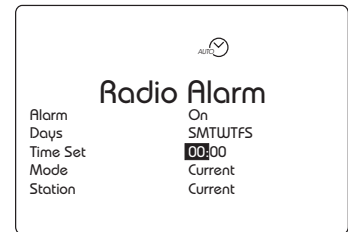
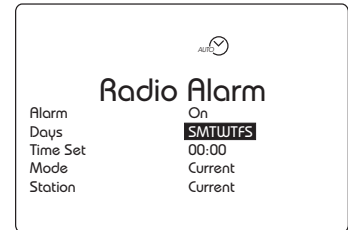
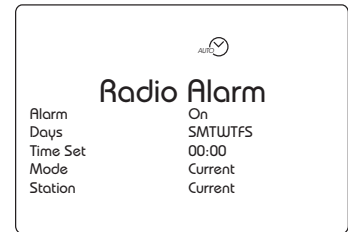

Radio Alarm cont.

14. Rotate the **Tuning control** until *Mode* line is highlighted in the display (default is *Current*)

15. Press in and release the **Tuning Control** to select. Rotate the **Tuning control** to select required mode - choose from *Current*, *FM* or *DAB*.

If *Current* is selected the current Band and station will be used for radio alarm

16. Press in and release the **Tuning control** to confirm the selection.

17. Further options are available to allow a different band and station to be selected for radio alarm.

18. Repeatedly press and release the **Setup button** until the display returns to show normal station mode.

19. The Radio alarm active symbol will appear in the display.

20. Press the **On/Off button** to switch off your radio. The alarm will sound on the selected days at the preset time.

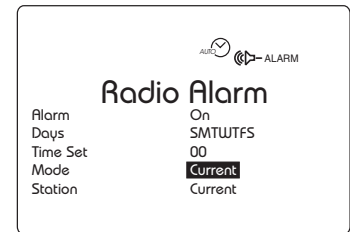
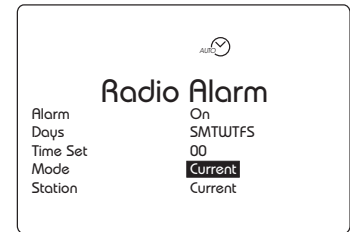
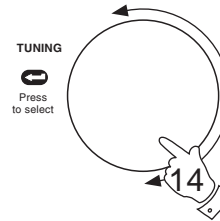

Snooze function

1. The radio or buzzer alarm can be silenced for 5 minutes by pressing **Any button (except On/Off)**. This sequence can be repeated during the 60 minutes alarm period.

Set-up

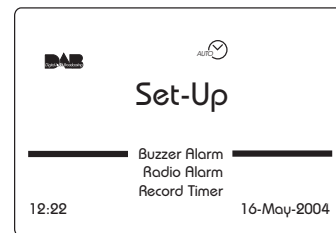

Sleep timer

Your radio can be set to turn off after a preset time has elapsed.

1. Press the **Setup button** to enter *Set-up* mode.
2. Rotate the **Tuning control** until the *Sleep* section appears between the two black lines on the display.
3. Press in and release the **Tuning control** to select the *Sleep* section.
4. Press in and release the **Tuning control** to enter adjustment mode.

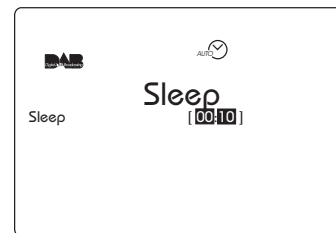
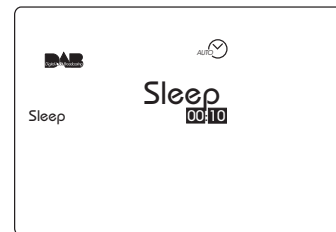
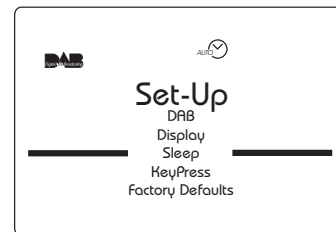
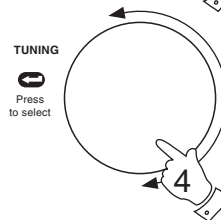
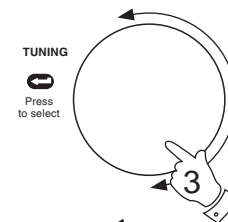
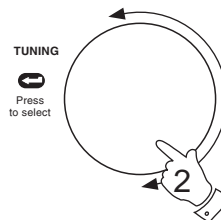

continued on next page

Sleep timer cont.

5. Rotate the **Tuning control** to set the *Sleep* time (max 1 hour 30 minutes in 5 minute steps). This now becomes new default sleep time.
6. Press in and release the **Tuning control** to confirm the selection.
7. Repeatedly press and release the **Setup button** until the display returns to show normal station mode.
8. Whilst your radio is switched on the *Sleep* timer may be activated by pressing and holding down the **On/Off button** until the sleep symbol  appears in the display. Your radio will switch off after the preset sleep time has elapsed.

Note: Once the default sleep time is set the sleep timer may be activated by pressing and holding in the **On/Off button** until the  symbol appears in the display. It is not necessary to go through the sleep time setup again.

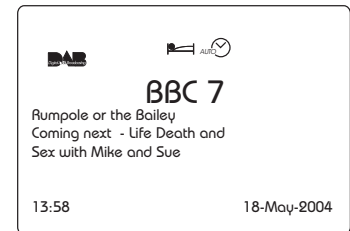
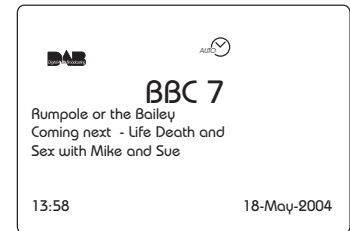
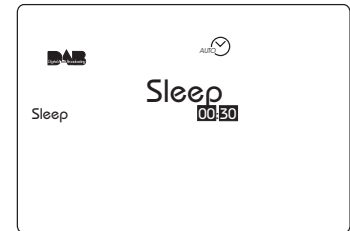
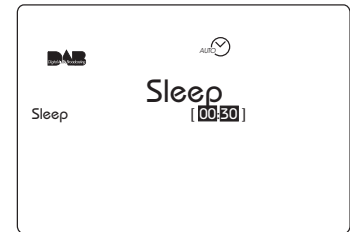
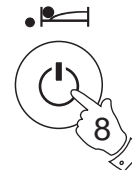
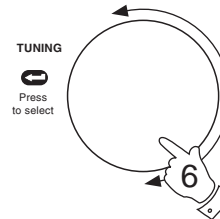
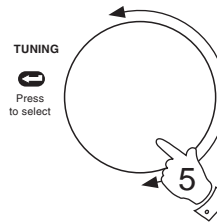

Display settings

Your radio has three user configurable display settings:-

Display settings - Display saving

Enables screen to be blanked when radio is switched off i.e. no Clock/Date display.

1. Press the **Setup button** to enter *Setup* menu.
2. Rotate the **Tuning control** until the *Display* section appears between the two black lines on the display. Press in and release the **Tuning control** to confirm the selection
3. Rotate the **Tuning control** until the *Display Saving* line is highlighted in the display.
4. Press in and release the **Tuning control** to enter adjustment mode. Rotate the **Tuning control** to select *Display Saving* Yes or No.
5. Press in and release the **Tuning control** to confirm the selection.
6. Repeatedly press and release the **Setup button** until the display returns to show normal station mode.

Set-up

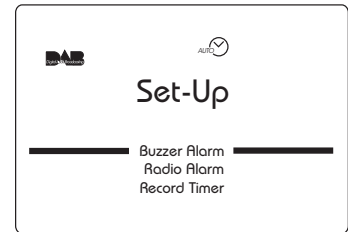

TUNING
Press to select

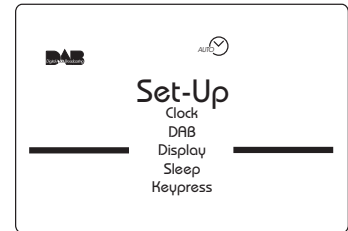
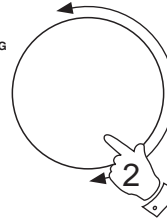

TUNING
Press to select

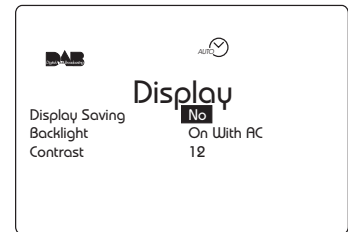
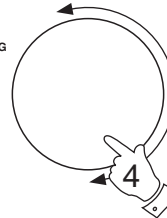

Set-up



Display settings - Backlight

This can be set to *Off* (always off), *On* (always on), *On with AC* (on when using AC adaptor) or *Keypress* (backlight switches on for 12 seconds following any key press).

Note: If backlight is set to On (always on) battery life will be reduced.

1. Press the **Setup button** to enter *Setup* menu.
2. Rotate the **Tuning control** until the *Display* section appears between the two black lines on the display. Press in and release the **Tuning control** to confirm the selection
3. Rotate the **Tuning control** until the *Backlight* line is highlighted in the display.
4. Press in and release the **Tuning control** to enter adjustment mode. Rotate the **Tuning control** to select required backlight mode e.g. *On*, *Off*, *On with AC* or *Keypress*.
5. Press in and release the **Tuning control** to confirm the selection.
6. Repeatedly press and release the **Setup button** until the display returns to show normal station mode.

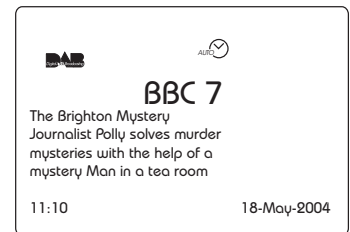
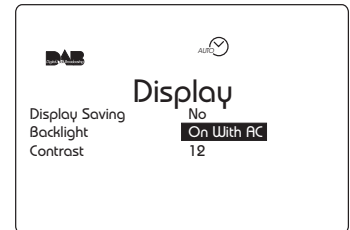
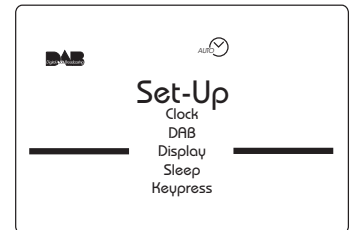
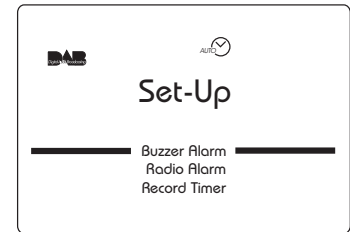
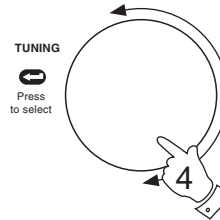
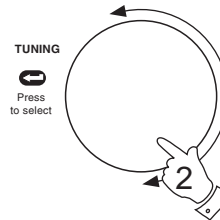

Display settings - Contrast

This can be changed to suit lighting conditions (default setting is 12)

1. Press the **Setup button** to enter *Setup* menu.
2. Rotate the **Tuning control** until the *Display* section appears between the two black lines on the display. Press in and release the **Tuning control** to confirm the selection
3. Rotate the **Tuning control** until the *Contrast* line is highlighted in the display.
4. Press in and release the **Tuning control** to enter adjustment mode. Rotate the **Tuning control** to select required contrast level.
5. Press in and release the **Tuning control** to confirm the selection.
6. Repeatedly press and release the **Setup button** until the display returns to show normal station mode.

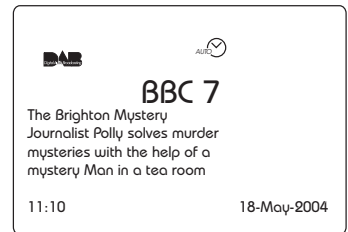
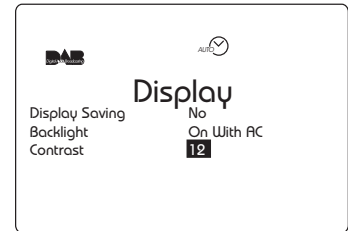
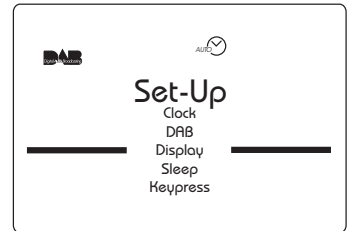
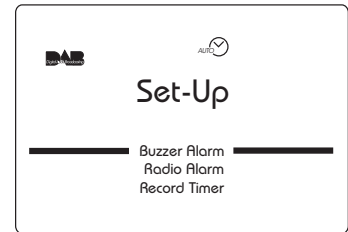
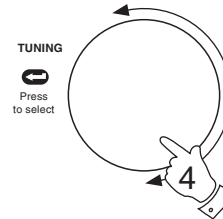
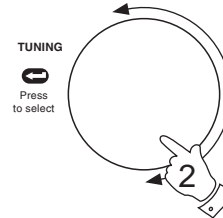

KeyPress settings - Timeout

The tuning display screen can be set to have a *Timeout* e.g. if no keypress within 5 seconds display will revert to previous screen.

1. Press the **Setup button** to enter *Setup* menu.
2. Rotate the **Tuning control** until the *KeyPress* section appears between the two black lines on the display. Press in and release the **Tuning control** to confirm the selection
3. Rotate the **Tuning control** until the *Timeout* line is highlighted in the display.
4. Press in and release the **Tuning control** to enter adjustment mode. Rotate the **Tuning control** to select required *Timeout* setting (Yes or No)
5. Press in and release the **Tuning control** to confirm the selection.
6. Repeatedly press and release the **Setup button** until the display returns to show normal station mode.

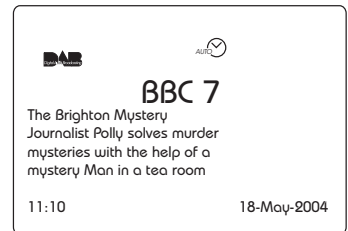
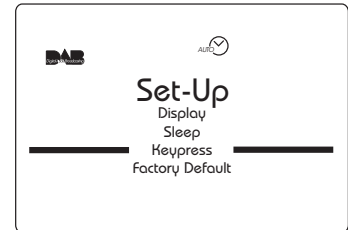
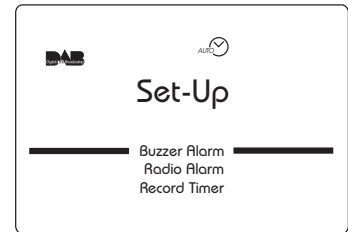
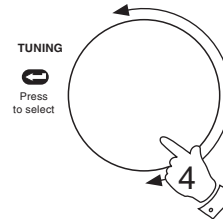
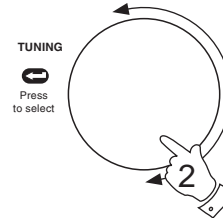

KeyPress settings - KeyBeep

Your radio can be set to provide an audible beep each time a key is pressed.

1. Press the **Setup button** to enter *Setup* menu.
2. Rotate the Tuning **control** until the *KeyPress* section appears between the two black lines on the display. Press in and release the **Tuning control** to confirm the selection
3. Rotate the **Tuning control** until the *KeyBeep* line is highlighted in the display.
4. Press in and release the **Tuning control** to enter adjustment mode. Rotate the **Tuning control** to select required *KeyBeep* setting (Yes or No)
5. Press in and release the **Tuning control** to confirm the selection.
6. Repeatedly press and release the **Setup button** until the display returns to show normal station mode.

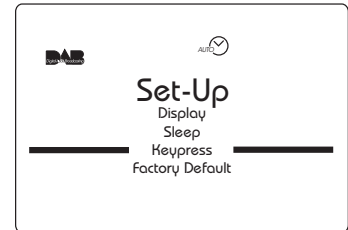
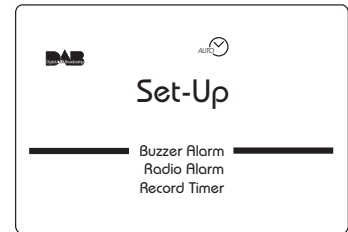
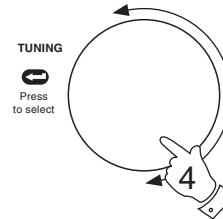
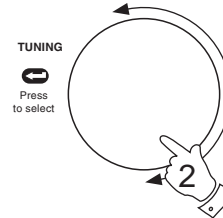

Factory default

This setting clears all station presets, service list and returns all variable settings to their factory defaults.

1. Press the **Setup** button to enter *Setup* menu.
2. Rotate the **Tuning control** until the *Factory Default* line is highlighted in the display. Press in and release the **Tuning control** to enter adjustment mode.
3. Rotate the **Tuning control** to select Yes. Press in and release the **Tuning control** to confirm the selection.
4. The display will blank and after a few seconds your radio will enter DAB Auto Tune.

Set-up

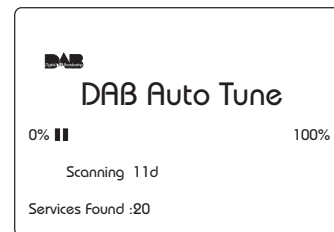
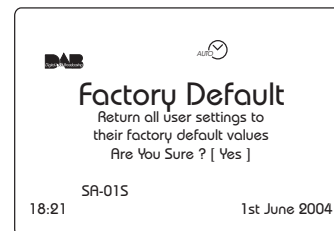
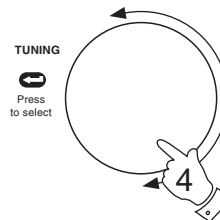
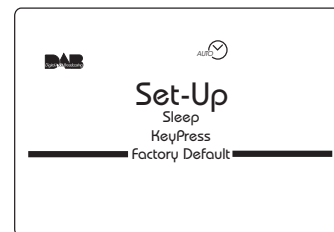
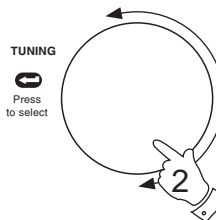
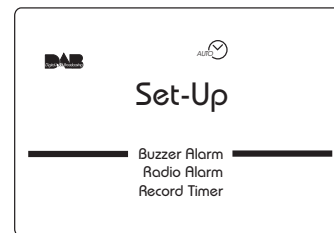

Headphone socket

1. A 3.5mm **Headphone Socket** located on the left side of your radio is provided for use with either headphones or an earpiece. Inserting a plug automatically mutes the internal loudspeaker.
2. On the FM band if a station being received is weak some hiss may be audible. To reduce the hiss press and hold in the **Tuning control** until the display shows *Information FM: Mono* your radio will switch to mono mode.
3. To return to stereo mode press and hold in the **Tuning control** until the display shows *Information FM: Stereo* your radio will switch back to stereo mode.

Note: Stereo is only available when using earphone/headphones

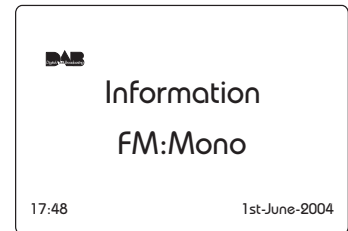
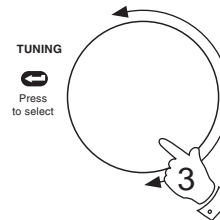
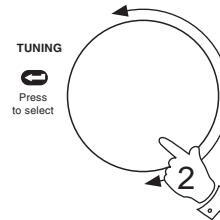
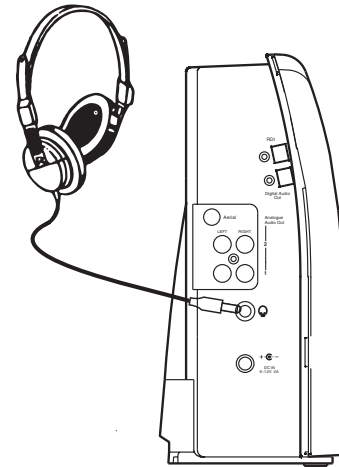

General

Do not allow this radio to be exposed to water, steam or sand. Do not leave your radio where excessive heat could cause damage. It is recommended that the DAB band be used wherever possible as better results in terms of quality and freedom from interference will usually be obtained than on the FM band.

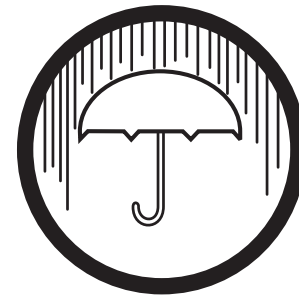
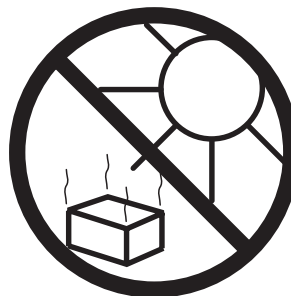

Specifications

AC	230V  50Hz via adaptor.
Batteries	4 x IEC size LR20 (D size)
Battery Life	Approx. 25hrs of listening when used for 4 hours a day at normal volume using alkaline batteries. (PausePlus storage and Backlight off)
Frequency Coverage	FM 87.5 - 108MHz DAB 174.928 - 239.200MHz

Circuit Features

Loudspeaker	100mm diameter 4ohms
Output Power	1.8 Watts
Headphone socket	3.5mm dia stereo
Audio 1 output	2 x RCA
Audio 2 output	2 x RCA
Optical output	TosLink
Aerial System FM	Telescopic aerial
DAB	Telescopic aerial

Guarantee

This instrument is guaranteed for twelve months from the date of delivery to the original owner against failure due to faulty workmanship or component breakdown, subject to the procedure stated below. Should any component or part fail during this guarantee period it will be repaired or replaced free of charge.

The guarantee does not cover:

1. Damage resulting from incorrect use.
2. Consequential damage.
3. Receivers with removed or defaced serial numbers.

N.B. Damaged or broken telescopic aerials will not be replaced under guarantee.

Procedure:

Any claim under this guarantee should be made through the dealer from whom the instrument was purchased. It is likely that your Roberts' dealer will be able to attend to any defect quickly and efficiently, but should it be necessary the dealer will return the instrument to the company's service department for attention. In the event that it is not possible to return the instrument to the Roberts' dealer from whom it was purchased, please contact Roberts Radio Technical Services at the address shown on the rear of this manual.

ROBERTS RADIO TECHNICAL SERVICES

97-99 Worton Road

Isleworth Middlesex

TW7 6EG

Technical Helpline :- 020 8758 0338 (*Mon-Fri during office hours*)

